

serie **L design**

CONI 70 G



FINITURE DI SERIE SERIENAUSFÜHRUNG



CONI 70 G



serie **L design**

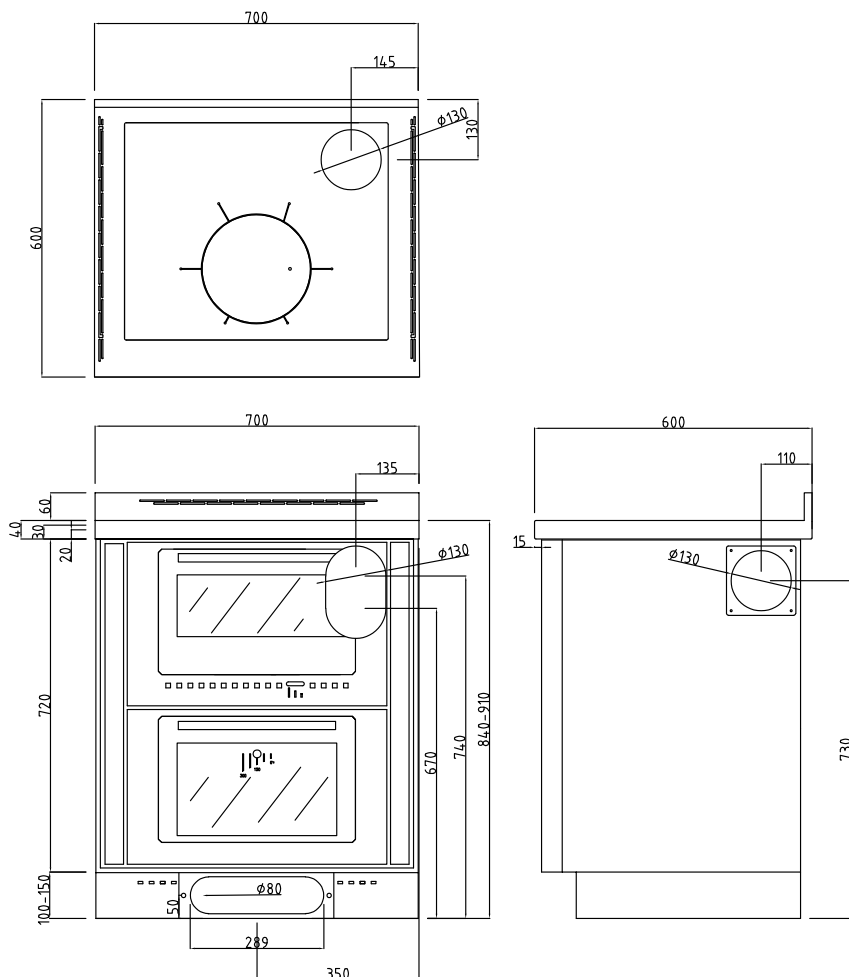

CARATTERISTICHE DI SERIE SERIENMÄSSIGE EIGENSCHAFTEN

- ✓ Dimensioni / Abmessungen: **L 700 x H 840/910 x P 600**
- ✓ Zoccolo Telescopico / Teleskopsockel: **H 100 - 150 mm INOX**
- ✓ Porta-fuoco tripli vetri / Feuertüre dreifachverglast
- ✓ Alzatina / Plattenwinkel: **60 mm**
- ✓ Uscita fumi / Rauchrohranschluss: **Ø 130 mm**
- ✓ Fianchi passivi / Isolierte Seiten
- ✓ Griglia a letto di cenere / Verschließbarer Planrost
- ✓ SBS Save Brick System / SBS Griglia protettiva mattoni
- ✓ Kit aria esterna chiudibile / Außenluftanschlussstutzen verschließbar: **Ø 80 mm**
- ✓ Piedini livellatori / Nivellierfüße
- ✓ Peso / Gewicht: **237 kg**
- ✓ Potenza calorifica Nominale / Nennwärmeleistung: **9 kW**
- ✓ Rendimento / Wirkungsgrad: **84,1%**

CONI 70 G



serie **L design**



VARIAZIONI DI SERIE VARIANTEN DER SERIENAUSSTATTUNG

- +** Piano di Lavoro / Herdkranz: **20 mm** diritto / gerade, **30 - 40 mm** diritto / gerade mezzo toro / abgerungen con o senza alzatina / mit oder ohne Plattenwinkel

- +** Scarico fumi superiore / posteriore / laterale destro o sinistro
Rauchrohranschluss oben / hinten / seitlich links oder rechts

- +** Piastra in acciaio con disco: **Ø 235 mm** o vetroceramica
Herdplatte Stahl mit Kochlochdeckel: **Ø 235 mm** oder Glaskeramik